

ISO Cylinders
Magnetic Piston
Double Acting
Ø 10 to 25 mm

- Magnetic piston as standard
- Conforming to ISO 6432
- Corrosion resistance
- Buffer or adjustable cushioning
- Nose mounting nut and piston rod locknut as standard



Technical Data

Medium:

Compressed air, filtered, lubricated or non-lubricated

Standard:

ISO 6432

Operation:

Double acting with buffer or adjustable cushioning

Operating Pressure:

1 to 10 bar

Operating Temperature:

-10°C* to +80°C max.

*Consult our Technical Service for use below +2°C

Cylinder Diameters:

10, 12, 16, 20, 25 mm (buffer cushioning)

16, 20, 25 mm (adjustable cushioning)

Strokes:

Standard, see page N 1.5.021.02

Non-standard up to 500 mm max. available

Materials:

Barrel: Stainless steel (Austenitic)

End covers: Clear anodised aluminium alloy

Piston rod: Stainless steel (Austenitic)

Buffer: Polyurethane

Wiper: Polyurethane

Seals: Nitrile rubber

Ordering Examples

See page N 1.5.021.02

Mountings and Switches

See page N 1.5.021.03

Guide Blocks

QM/8000/61/* – Roller Bearing

See page N 1.5.021.08

Alternative Models

Single acting cylinders see page N 1.4.031.01

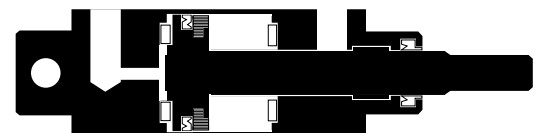
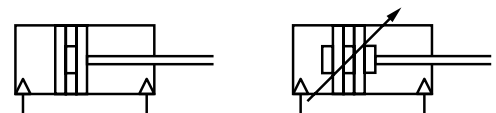



Cylinder Variants

Symbol	Model non-magnetic piston	Symbol	Model magnetic piston	Description	Dimensions Page
			RM/8000/M	Standard cylinders	4
			RM/8000/MC	Cylinders with central rear port	4
			RM/8000/MF	Cylinders with flat rear cover	4
	TRM/8000		—	Cylinders Ø 16 to 25 mm with heat resistant seal (150°C max.)	4
	TRM/8000/IU		RM/8000/MU	Cylinders with extended piston rod	4
				Note: Extended piston rod 75 mm: *RM/8***/IU/Stroke/75	
			RM/8017/M	Cylinder Ø 16 mm with adjustable cushioning	4
			RM/8021/M	Cylinder Ø 20 mm with adjustable cushioning	4
			RM/8026/M	Cylinder Ø 25 mm with adjustable cushioning	4
			RM/8000/JM	Cylinder with double ended piston rod (Ø 16 to 25 mm)	5
			RM/8000/N2	Cylinders with non-rotating piston rod (Ø 12 to 25 mm)	5
			RM/8000/L4	Cylinder Ø 12 to 25 mm with locking unit (PASSIVE). Locking is achieved by spring force on removal of the signal to the unit. Operating pressure for locking unit: 4 to 10 bar	5

For combinations of cylinder variants consult our Technical Service.

Standard Strokes (buffer cushioning)

Cylinder Ø	Strokes (mm)									
	10	25	40	50	80	100	125	160	200	250
10	●	●	●	●	●	●				
12	●	●	●	●	●	●	●	●	●	
16	●	●	●	●	●	●	●	●	●	●
20	●	●	●	●	●	●	●	●	●	●
25	●	●	●	●	●	●	●	●	●	●

Standard Strokes (adjustable cushioning)

Cylinder Ø	Strokes (mm)									
	10	25	40	50	80	100	125	160	200	250
10										
12										
16		●	●	●	●	●	●	●	●	●
20		●	●	●	●	●	●	●	●	●
25		●	●	●	●	●	●	●	●	●

Model Codes

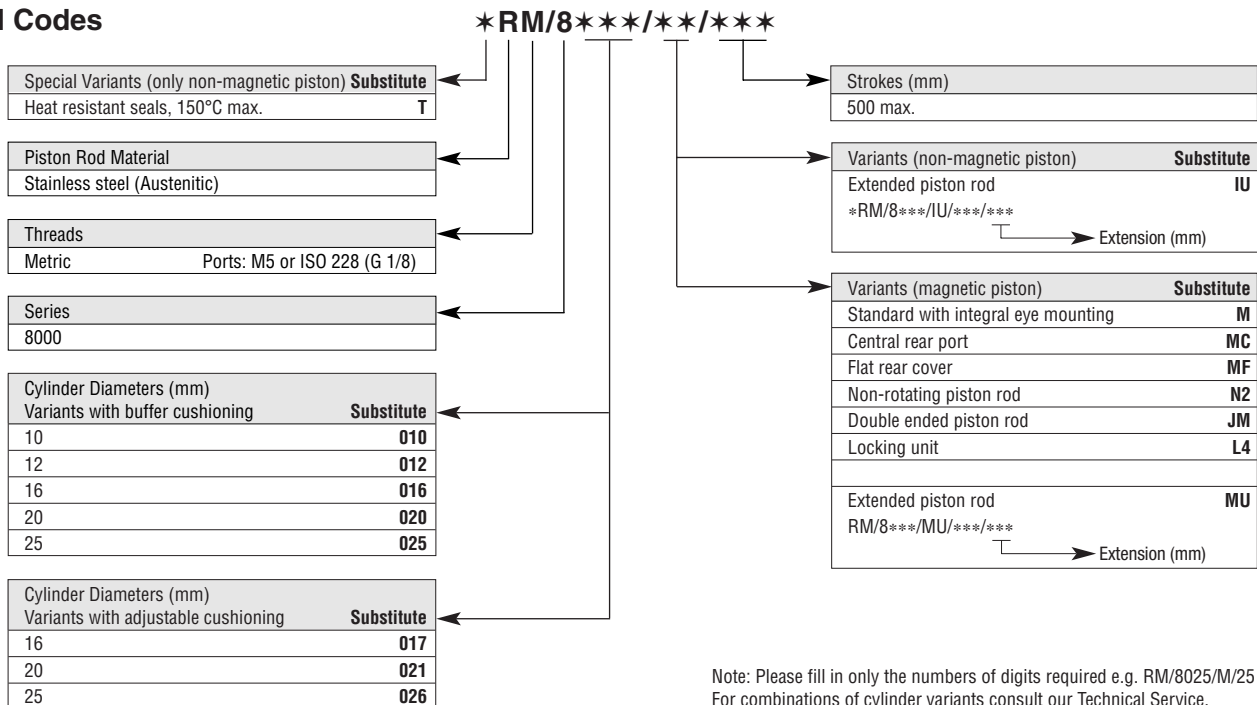

Note: Please fill in only the numbers of digits required e.g. RM/8025/M/25
For combinations of cylinder variants consult our Technical Service.

Ordering Examples

Cylinders

To order a basic 25 mm bore cylinder with a 50 mm stroke quote: **RM/8025/M/50**

Mountings

To order a front flange mounting style 'G' for 25 mm bore cylinder quote: **M/P 19409**

Switches

To order a reed switch with LED and 2 m cable length quote: **M/50/LSU/2V**

Switch Mounting Brackets

To order a bracket for magnetically operated switches M/50; 25 mm bore cylinder quote: **QM/33/025/22**



Mountings

	Style 'AK'	Style 'B', 'G'	Style 'C'	Style 'F'	Style 'FH'	Style 'L'	Style 'L2'
Cylinder Ø	Page 07	Page 06	Page 06	Page 07	Page 10	Page 06	Page 07
10	QM/8010/38	M/P 19407	M/P 19369	QM/8010/25	—	QM/947	QM/8010/44
12	QM/8012/38	M/P 19408	M/P 19389	QM/8012/25	QM/8012/34	QM/8012/24	QM/8012/44
16	QM/8012/38	M/P 19408	M/P 19389	QM/8012/25	QM/8012/34	QM/8012/24	QM/8012/44
20	QM/8020/38	M/P 19409	M/P 19406	QM/8020/25	QM/8020/34	QM/8020/24	QM/8020/44
25	QM/8025/38	M/P 19409	M/P 19406	QM/8025/25	QM/8020/34	QM/8020/24	QM/8020/44
	Style 'N'	Style 'UF'	Guide Blocks	Locking Units 'Passive'	Switch Mounting Brackets # ≥ 15 mm stroke	Switch Mounting Brackets # < 15 mm stroke	
Cylinder Ø	Page 09	Page 07	Page 08	Page 05	Page 10	Page 10	
10	M/P 1501/90	QM/8010/32	—	—	QM/33/010/22	QM/33/010/23	
12	M/P 13834	QM/8012/32	QM/8012/61/*	QM/8012/59	QM/33/012/22	QM/33/016/23	
16	M/P 13834	QM/8012/32	QM/8012/61/*	QM/8012/59	QM/33/016/22	QM/33/016/23	
20	M/P 13615	QM/8020/32	QM/8020/61/*	QM/8020/59	QM/33/020/22	QM/33/020/23	
25	M/P 13615	QM/8025/32	QM/8025/61/*	QM/8025/59	QM/33/025/22	QM/33/025/23	

* Insert standard stroke length (50, 100, 160, 200, 250; optional 320, 400, 500) in mm
M/50, QM/33, QM/34 or QM/134

Switches

	Cable	Plug (M8x1)	Without LED	With LED	With LED (plug in connector)
Model	Ø 8 mm	Ø 8 mm	Ø 8 mm	Ø 8 mm	
Reed	M/50/LSU/.. M/50/RAC/5V	M/50/LSU/CP	QM/33/C	QM/34	QM/34/P
Solid state	M/50/EAP/.. M/50/EAN/..	M/50/EAP/CP M/50/EAN/CP	—	QM/134	QM/134/P

Model	Reed	Solid state	Voltage V a.c.	V d.c.	Current Max.	Temperature °C	LED	Features	Cable Length	Cable Type	Plug-in Cable Straight	90°	Catalogue Page
M/50/LSU/**V	—	—	10 to 240	10 to 170	180 mA	-20° to +80°	●	—	2, 5, 10 m	PVC 2 x 0,25	—	—	N 4.3.005
M/50/LSU/5U	—	—	10 to 240	10 to 170	180 mA	-20° to +80°	●	—	5 m	PUR 2 x 0,25	—	—	N 4.3.005
M/50/RAC/5V	—	—	10 to 240	10 to 170	180 mA	-20° to +80°	—	Changeover	5 m	PVC 3 x 0,25	—	—	N 4.3.005
M/50/LSU/CP	—	—	10 to 60	10 to 75	180 mA	-20° to +80°	●	Plug M8x1	5 m	—	M/P73001/5	—	N 4.3.005
—	M/50/EAP/**V	—	10 to 30	10 to 30	150 mA	-20° to +80°	●	PNP	2, 5, 10 m	PVC 3 x 0,25	—	—	N 4.3.005
—	M/50/EAP/CP	—	10 to 30	10 to 30	150 mA	-20° to +80°	●	PNP, plug M8x1	5 m	—	M/P73001/5	—	N 4.3.005
—	M/50/EAN/**V	—	10 to 30	10 to 30	150 mA	-20° to +80°	●	NPN	2, 5, 10 m	PVC 3 x 0,25	—	—	N 4.3.005
—	M/50/EAN/CP	—	10 to 30	10 to 30	150 mA	-20° to +80°	●	NPN, plug M8x1	5 m	—	M/P73001/5	—	N 4.3.005
QM/33/C/**	—	—	10 to 110	10 to 175	0,25 A	-20° to +80°	—	Changeover	5 m	PVC 2 x 0,34	—	—	N 4.3.051
QM/34/**	—	—	10 to 30	10 to 30	1 A	-20° to +80°	●	Output: Positive	2, 5, 10 m	PVC 3 x 0,34	—	—	N 4.3.051
QM/34/P	—	—	10 to 30	10 to 30	1 A	-20° to +80°	●	Output: Positive	5 m	PVC 3 x 0,25	M/P34614/5	M/P34615/5	N 4.3.051
QM/34/S/**	—	—	10 to 240	10 to 240	0,5 A	-20° to +80°	●	—	2, 5, 10 m	PVC 2 x 0,34	—	—	N 4.3.051
QM/34/N/**	—	—	10 to 30	10 to 30	1 A	-20° to +80°	●	Output: Negative	2, 5 m	PVC 3 x 0,34	—	—	N 4.3.051
—	QM/134/**	—	10 to 30	10 to 30	0,2 A	-20° to +80°	●	PNP	2, 5 m	PVC 3 x 0,34	—	—	N 4.3.055
—	QM/134/P	—	10 to 30	10 to 30	0,2 A	-20° to +80°	●	PNP	5 m	PVC 3 x 0,25	M/P34614/5	M/P34615/5	N 4.3.055
—	QM/134/E/**	—	10 to 30	10 to 30	0,2 A	-20° to +80°	●	Pulse stretcher	5 m	PVC 3 x 0,34	—	—	N 4.3.055
—	QM/134/N/**	—	10 to 30	10 to 30	0,2 A	-20° to +80°	●	NPN	2, 5 m	PVC 3 x 0,34	—	—	N 4.3.055
—	QM/134/N/P	—	10 to 30	10 to 30	0,2 A	-20° to +80°	●	NPN	5 m	PVC 3 x 0,25	M/P34614/5	M/P34615/5	N 4.3.055
—	QM/134/X/**	—	8,2	2,2/1 mA	—	-25° to +75°	●	NAMUR	5 m	PVC 2 x 0,34	—	—	N 4.3.055

** Insert cable length

Full information on switches (technical data, polyurethane cable, dimensions etc.) please see catalogue pages



Theoretical Forces • Air Consumption • Cushioning

Cylinder Ø	Theoretical forces (N) at 6 bar		Air consumption (l/cm stroke) at 6 bar		Model	Cushion length (mm)	Initial volume (cm ³)
	Outstroke	Instroke	Outstroke	Instroke			
10	47,1	39,6	0,006	0,005	—	—	—
12	67,8	51	0,008	0,006	—	—	—
16	120	104	0,014	0,013	8017	16	2,4
20	188	158	0,022	0,019	8021	19	4,4
25	294	247	0,035	0,028	8026	19	7,2

BASIC DIMENSIONS

RM/8000/M – Standard Cylinders with Integral Eye Mounting

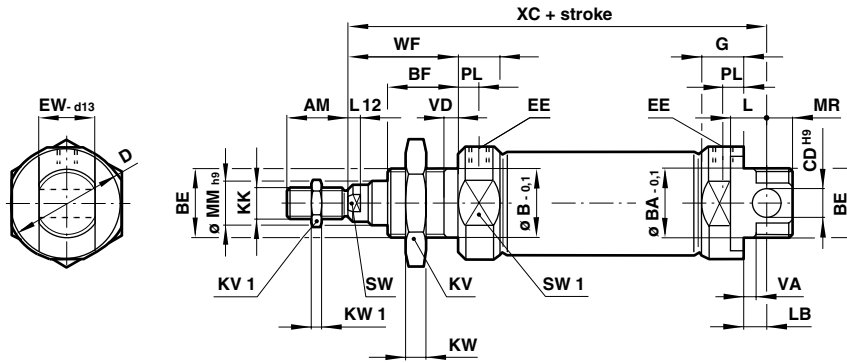

Cylinder Ø	AM	ØB/BA-0,1	BE	BF	Ø CD H9	Ø D	EE	EW-0,1	G	KK	KV (A/F)	KV1 (A/F)	KW	KW1
10	12	12	M12x1,25	12	4	16,5	M5	7,9	9	M4	19	7	6	2
12	16	16	M16x1,5	17	6	21	M5	11,9	9,5	M6	22	10	5	3
16	16	16	M16x1,5	17	6	21	M5	11,9	9,5	M6	22	10	5	3
20	20	22	M22x1,5	20	8	30	G1/8	15,9	15	M8	27	13	8	4
25	22	22	M22x1,5	22	8	30	G1/8	15,9	15	M10x1,25	27	17	8	5

Cylinder Ø	L	L12	LB	Ø MM h9	MR	PL	SW (A/F)	SW1 (A/F)	WF	VA/VD	XC	at 0 mm	per 25 mm
10	6	—	2	4	8	5,5	—	14	16	1,5	64	0,034 kg	0,007 kg
12	9	3	3	6	8	5,5	5	19	22	2	75	0,058 kg	0,011 kg
16	9	3	4	6	7	5,5	5	19	22	2	82	0,070 kg	0,012 kg
20	12	3	3	8	11	8	7	27	24	2	95	0,145 kg	0,018 kg
25	12	4	7	10	9	8	9	27	28	2	104	0,200 kg	0,028 kg

CYLINDER VARIANTS

RM/8000/MC – Cylinders with Central Rear Port

RM/8000/MF – Cylinders with Flat Rear Cover

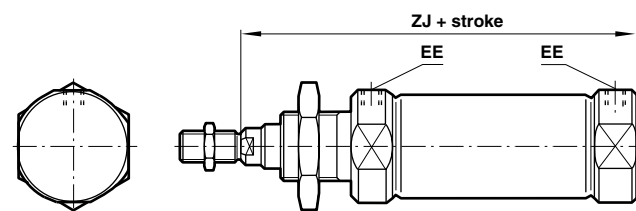
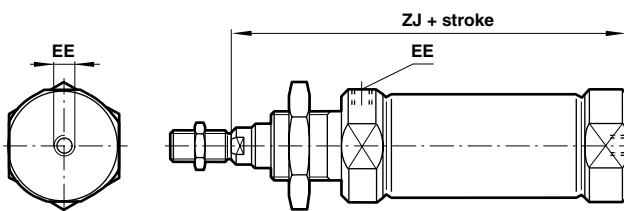

Cylinder Ø	EE	ZJ	at 0 mm	per 25 mm
10	M5	62	0,031 kg	0,007 kg
12	M5	72	0,052 kg	0,011 kg
16	M5	78	0,064 kg	0,012 kg
20	G1/8	92	0,130 kg	0,018 kg
25	G1/8	97	0,185 kg	0,028 kg

RM/8017/M, RM/8021/M, RM/8026/M – Cylinders with Adjustable Cushioning

Cylinder Ø	at 0 mm	per 25 mm
16	0,070 kg	0,012 kg
20	0,145 kg	0,018 kg
25	0,195 kg	0,028 kg



RM/8000/N2 – Cylinders with Non-rotating Piston Rod

Cylinder Ø	SW2 (A/F)	Torque max.	at 0 mm	per 25 mm
12	5	0,04 Nm	0,058 kg	0,011 kg
16	5	0,04 Nm	0,070 kg	0,012 kg
20	6	0,15 Nm	0,145 kg	0,018 kg
25	8	0,25 Nm	0,200 kg	0,028 kg

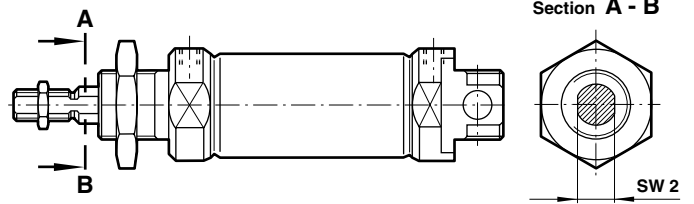

RM/8000/JM – Cylinders with Double Ended Piston Rod

Cylinder Ø	L8	ZM	at 0 mm	per 25 mm
16	56	100	0,080 kg	0,017 kg
20	68	116	0,165kg	0,028 kg
25	69	125	0,250 kg	0,043 kg

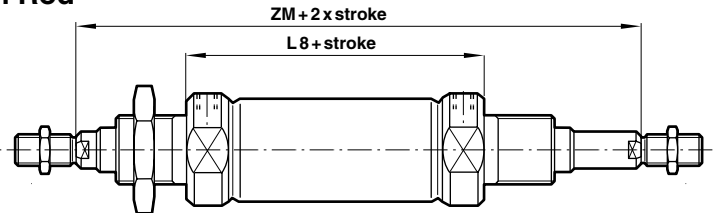

RM/8000/L4 – Cylinder with Locking Unit

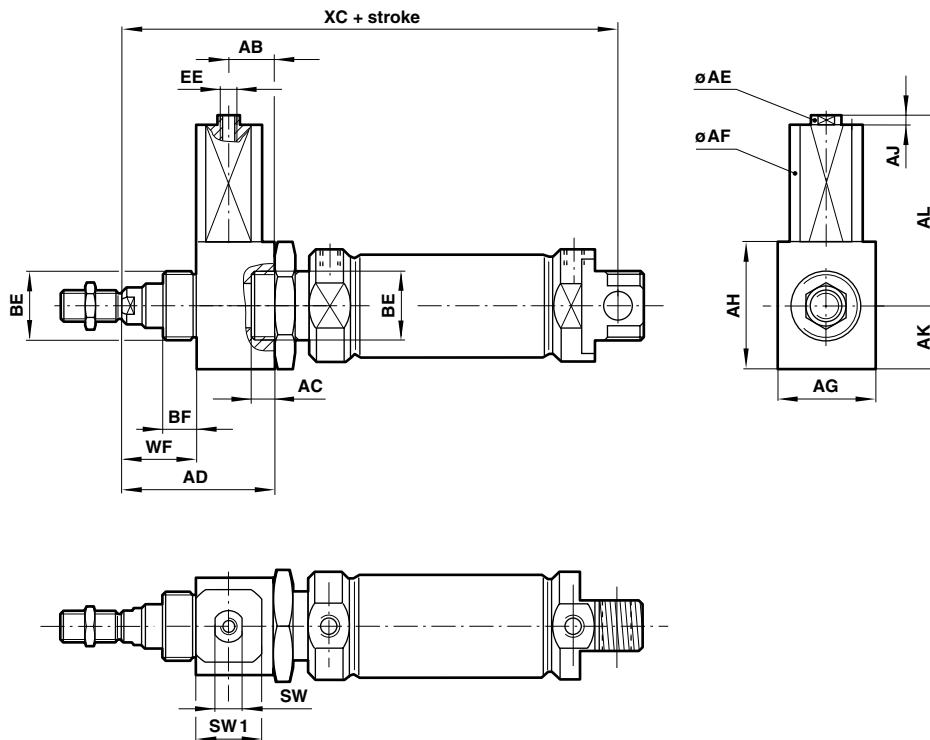

Cylinder Ø	AB	AC	AD	∅AE	∅AF	AG	AH	AJ	AL	AK
12	21	13	48,5	8,5	20	20	20	4	54	10
16	21	13	48,5	8,5	20	20	20	4	54	10
20	24	14	66	9	22	27	33	4,5	58,5	16,5
25	24	14	75	9	22	27	33	4,5	58,5	16,5

Cylinder Ø	BE	BF	EE	SW (A/F)	SW1 (A/F)	WF	XC	Locking Forces	at 0 mm	per 25 mm
12	M16x1,5	12	M5	8	18,5	18,5	109	200 N	0,130 kg	0,011 kg
16	M16x1,5	12	M5	8	18,5	18,5	116	200 N	0,140 kg	0,012 kg
20	M22x1,5	23	M5	8	20,5	31	145	350 N	0,300 kg	0,018 kg
25	M22x1,5	23	M5	8	20,5	30	151,5	400 N	0,360 kg	0,028 kg



MOUNTINGS

**M/P 19 . . . – Rear Flange Mounting Style ‘B’
Front Flange Mounting Style ‘G’**

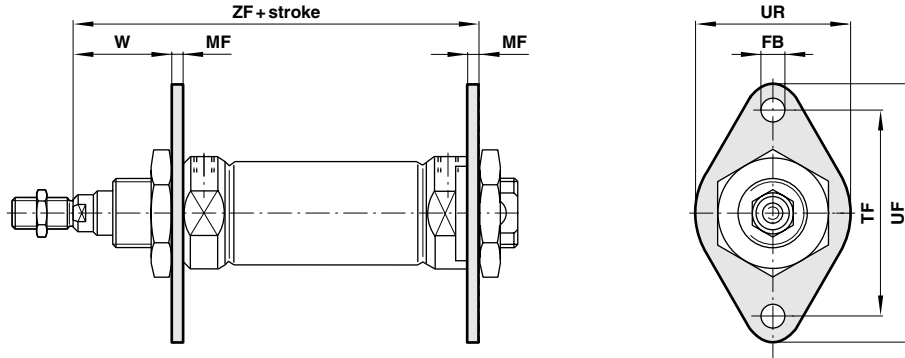

M/P 19 . . . – Foot Mounting Style ‘C’

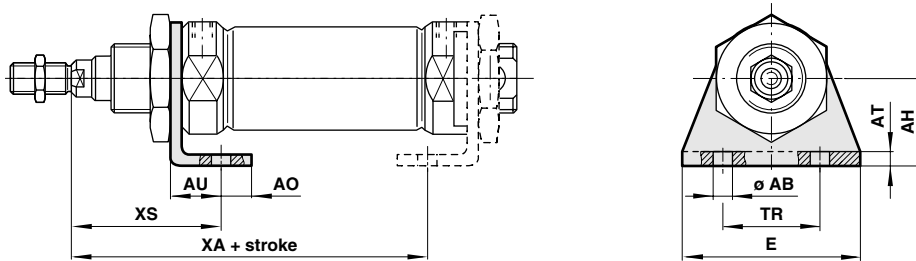

Cylinder Ø	Ø AB	AH	A0	AT	AU	E	Ø FB	MF	TF
10	4,5	16	6	2	10	35	4,5	3	30
12	5,5	20	6	3	13	43	5,5	4	40
16	5,5	20	6	3	13	43	5,5	4	40
20	6,6	25	7,5	4	16	53	6,6	5	50
25	6,6	25	7,5	4	16	53	6,6	5	50

Cylinder Ø	TR	UF	UR	W	XA	XS	ZF	Style ‘B’, ‘G’	Style ‘C’
10	25	40	22	13	54	24	65	0,020 kg	0,020 kg
12	32	51	28	18	62	32	76	0,030 kg	0,030 kg
16	32	51	28	18	68	32	82	0,030 kg	0,030 kg
20	40	63	38	19	80	36	97	0,050 kg	0,060 kg
25	40	63	38	23	85	40	102	0,050 kg	0,060 kg

QM/8000/24 – Rear Hinge Mounting Style ‘L’

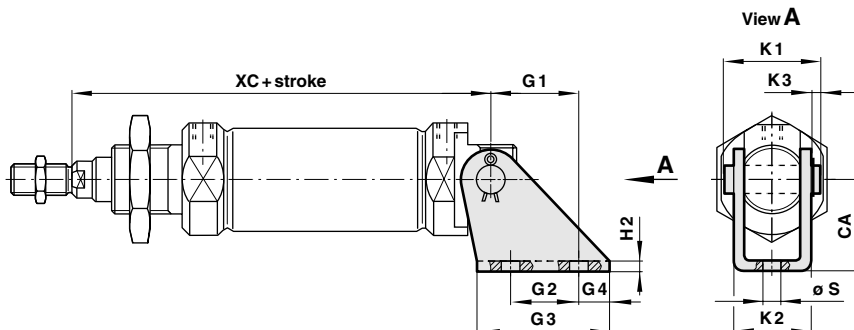

Cylinder Ø	CA	G1	G2	G3	G4	H2	K1	K2	K3	Ø S	XC	Style ‘L’
10	12	6,5	-	15	6	1	13,5	10,5	2	4,8	64	0,005 kg
12	20	18,5	15	30	8	1,5	20	15	3	5,5	75	0,020 kg
16	20	18,5	15	30	8	1,5	20	15	3	5,5	82	0,020 kg
20	25	20	15	35	10	2	25	20,5	3	6,6	95	0,040 kg
25	25	20	15	35	10	2	25	20,5	3	6,6	104	0,040 kg



QM/8000/44 – Rear Hinge Mounting Style ‘L2’

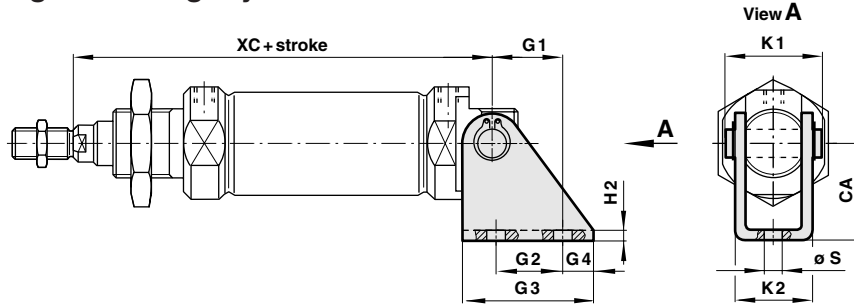

Cylinder Ø	CA	G1	G2	G3	G4	H2	K1	K2	Ø S	XC	Style ‘L2’
10	24	11	12,5	20	4	2,5	17,5	13	4,5	64	0,018 kg
12	27	13	15	25	5	3	23	18	5,5	75	0,035 kg
16	27	13	15	25	5	3	23	18	5,5	82	0,035 kg
20	30	16	20	32	6	4	29,5	24	6,6	95	0,077 kg
25	30	16	20	32	6	4	29,5	24	6,6	104	0,077 kg

QM/8000/38 – Piston Rod Swivel Mounting Style ‘AK’

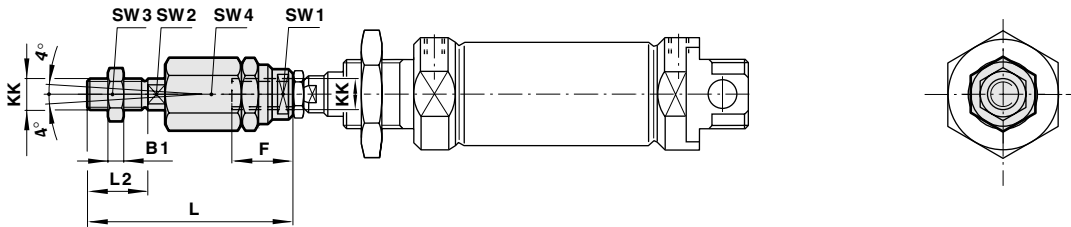

QM/8000/25 – Piston Rod Clevis Mounting Style ‘F’
(Corresponds to DIN ISO 8140)

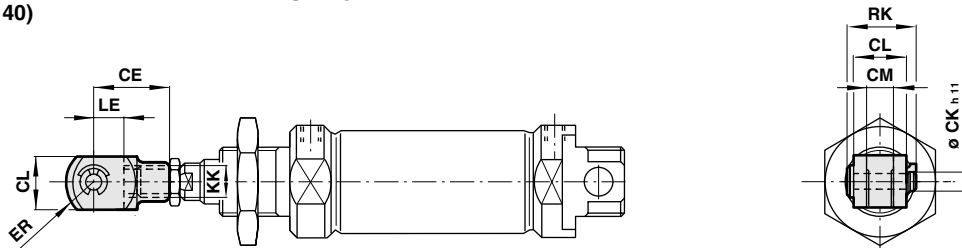

QM/8000/32 – Universal Piston Rod Eye Mounting Style ‘UF’
(Corresponds to DIN ISO 8139)

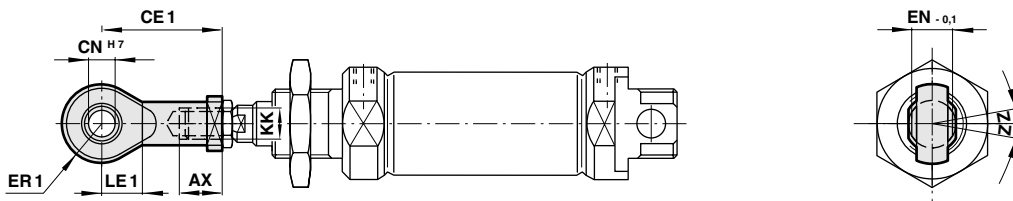

Cylinder Ø	AX	B1	CE	CE1	Ø CK _{n.11}	CL	CM	Ø CN _{H7}	EN-0,1	ER	ER1	F	KK
10	14	2	16	27	4	8	4	5	8	6,5	8	12,5	M4
12	14	3	24	30	6	12	6	6	9	9,5	9	14	M6
16	14	3	24	30	6	12	6	6	9	9,5	9	14	M6
20	16	4	32	36	8	16	8	8	12	13	11	18	M8
25	25	5	40	42	10	20	10	10	14	16	14	26	M10x1,25

Cylinder Ø	L	L2	LE	LE1	RK	SW1 (A/F)	SW2 (A/F)	SW3 (A/F)	SW4 (A/F)	Z	Style ‘AK’	Style ‘F’	Style ‘UF’
10	33	8	8	10	11,5	11	3,2	7	11	5°	0,015 kg	0,010 kg	0,020 kg
12	39	12	12	11	17,5	7	5	10	13	5°	0,024 kg	0,020 kg	0,020 kg
16	39	12	12	11	17,5	7	5	10	13	5°	0,024 kg	0,020 kg	0,020 kg
20	55	16	16	13	22	10	7	13	17	5°	0,054 kg	0,060 kg	0,050 kg
25	73	20	20	15	28	19	12	17	30	5°	0,233 kg	0,100 kg	0,080 kg



QM/8000/61/* – Guide Blocks with Roller Bearings

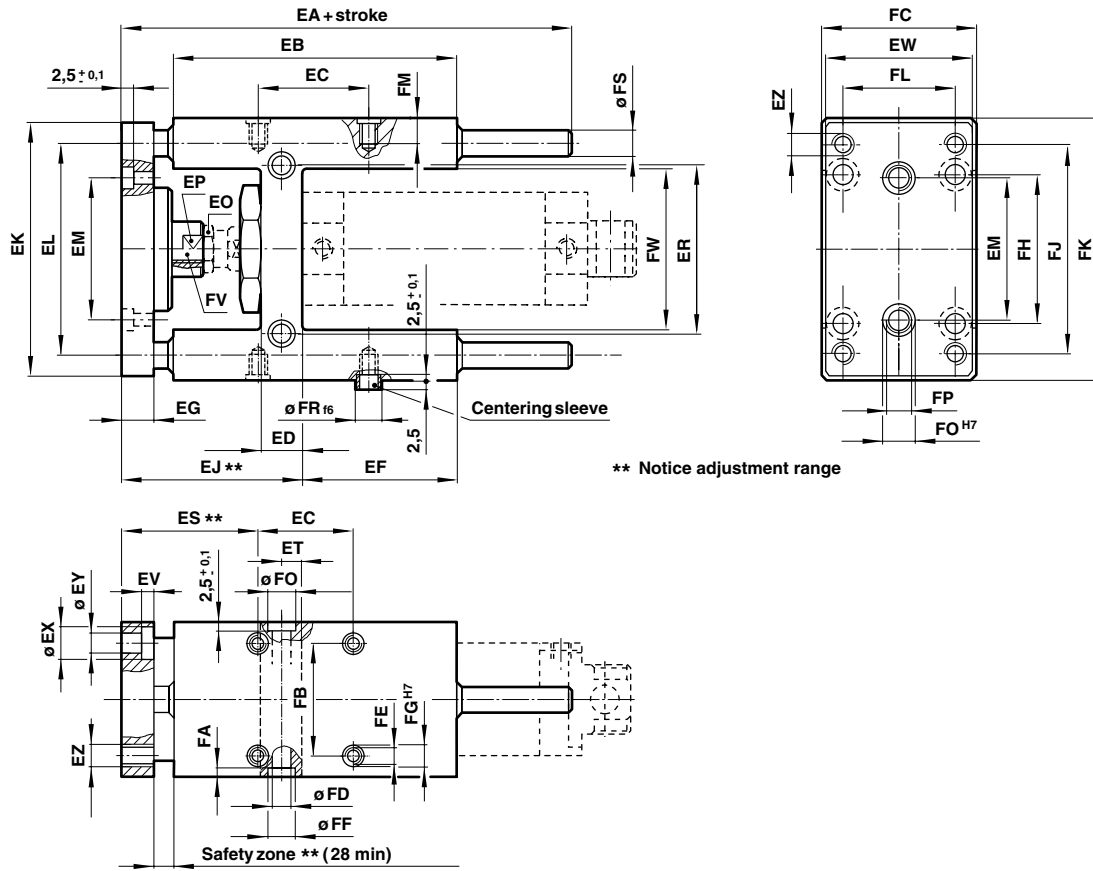

Cylinder \varnothing	EA	EB	EC	ED	EF	EG	EJ	EK	EL	EM
12 and 16	132	75	32,5	16,5	37	10	78	63	46	24
20	160	108	32,5	19	58	12	90	76	58	38
25	160	108	32,5	19	58	12	90	76	58	38
Cylinder \varnothing	EO	EP	ER	ES	ET	EV	EW	$\varnothing EX$	$\varnothing EY$	EZ
12 and 16	10	8	24	65	6,5	4,6	27	8	4,5	M4
20	13	13	38	75	8,5	5,7	32	10	5,5	M5
25	17	13	38	75	8,5	5,7	32	10	5,5	M5
Cylinder \varnothing	FA	FB	FC	$\varnothing FD$	FE	FF	$\varnothing FG^{H7}$	FH	FJ	FK
12 and 16	6	22	30	5,5	M 4	9	6	32	54	65
20	7	23	34	6,6	M 6	11	9	40	68	79
25	7	23	34	6,6	M 6	11	9	40	68	79
Cylinder \varnothing	FL	FM	$\varnothing FO^{H7}$	FP	$\varnothing FR_{16}$	$\varnothing FS$	FV	FW	at 0 mm	per 100 mm
12 and 16	15	10	9	M 5	6	8	M 6	27	0,40 kg	0,04 kg
20	20	14	9	M 6	9	10	M 8	37	0,65 kg	0,06 kg
25	20	14	9	M 6	9	10	M 10 x 1,25	37	0,65 kg	0,06 kg

Note: Supplied complete with cylinder mounting screws and two centering sleeves.



Maximum Load for QM/8000/61/*

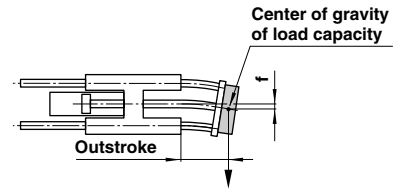
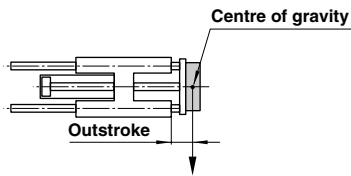

Max. load capacity is dependent on the outstroke of a horizontally installed guide unit. In the case of short stroke operation, the load capacity figures taken from the diagram must be multiplied by the correction factor (diagram 2). In the curves of load capacity (diagram 1), the short stroke corrections have already been taken into account for a outstroke > 60 mm.

The total deflection of guide rods will be determined by the addition of that due to own weight acc. to diagram 3 and that due to load capacity acc. to diagram 4.

Max. load capacity depending on outstroke

(diagram 1)

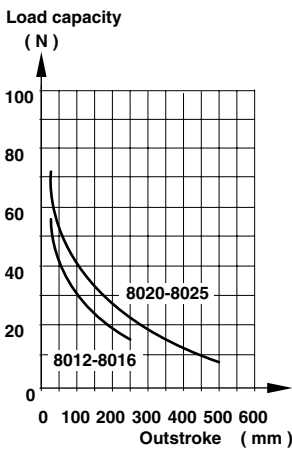

(diagram 2)

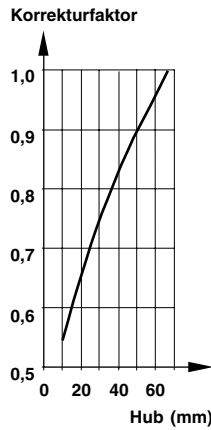

Deflection caused by own weight

(diagram 3)

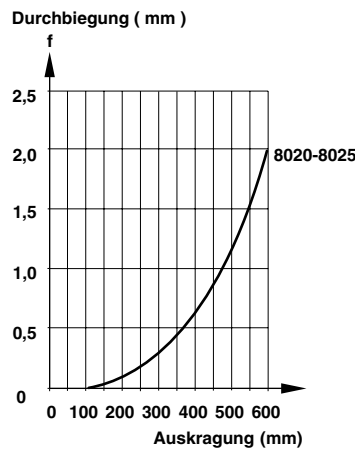

Deflection caused by a load of 10 N

(diagram 4)

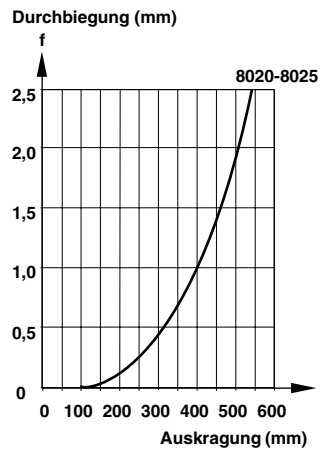

Reduction of load capacity for short stroke operation

In the case of shock load applications, the figures given in the diagrams above must be reduced by a factor of 2.

M/P1 . . . – Nose Nut Style ‘N’

Cylinder Ø	BE	KV (A/F)	KW	Style ‘N’
10	M12x1,25	19	6	0,010 kg
12	M16x1,5	22	5	0,009 kg
16	M16x1,5	22	5	0,009 kg
20	M22x1,5	27	8	0,017 kg
25	M22x1,5	27	8	0,017 kg

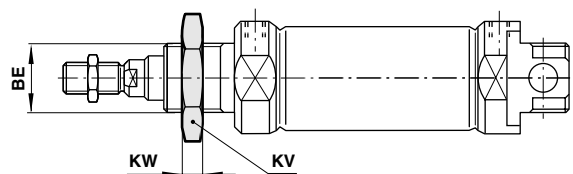



QM/8000/34 – Head (Cap) Detachable Trunnion Mounting Style ‘FH’

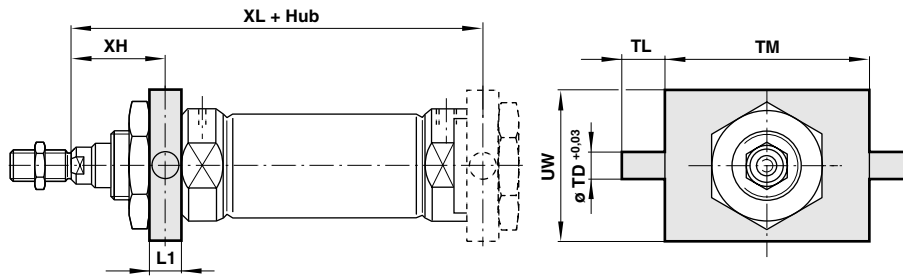

Cylinder \varnothing	L1	\varnothing TD +0.03	TL	TM	UW	XH	XL	Style 'FH'
12	8	6	10	38	25	18	—	0,051 kg
16	8	6	10	38	25	18	—	0,051 kg
20	8	6	10	46	30	20	96	0,067 kg
25	8	6	10	46	30	24	101	0,067 kg

SWITCH MOUNTING BRACKETS

QM/33/000/23 – Brackets

< 15 mm stroke

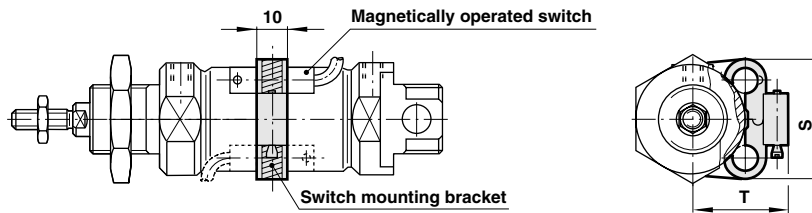

M/50, QM/33, QM/34, QM/134 (Ø 8 mm)

Cylinder \varnothing	S	T	Weight
10	27,5	19,5	0,007 kg
12	28,5	21,5	0,008 kg
16	29,5	23,5	0,008 kg
20	29,5	26	0,008 kg
25	31,5	28,5	0,007 kg

QM/33/000/22 – Brackets

≥ 15 mm stroke

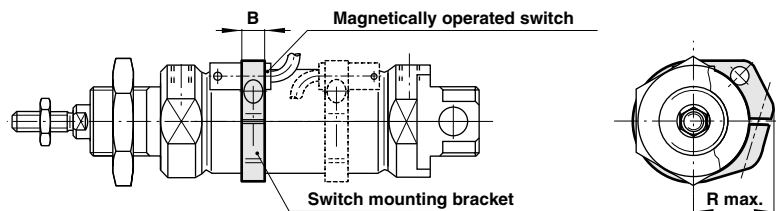

M/50, QM/33, QM/34, QM/134 (Ø 8 mm)

Cylinder \varnothing	B	R max.	Weight
10	8	16	0,003 kg
12	8	18	0,004 kg
16	10	20	0,006 kg
20	10	22	0,006 kg
25	10	24	0,007 kg